

ECRASAGE

SWAGER - STAUCHEN
EL CHAFADO - SCHIACCIATURA

APPAREILS A RECTIFIER MANUEL

Manual side dressing device - Egalisierapparate manuell - Aparato manual para rectificar manual
Apparecchio per rettificare manuale

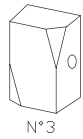
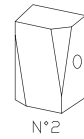
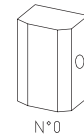
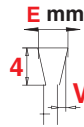
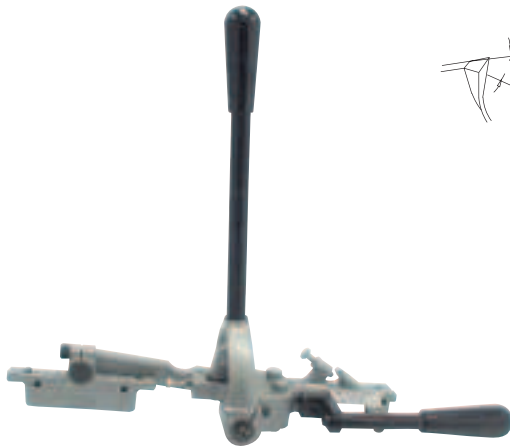

REF	V mm	e mm	UT	UC	CODE
RM0	0,07-0,6	0,8-1,47	1	1	RECT0006
RM1	0,07-0,74	0,8-1,47	1	1	RECT0003
RM2	0,35-0,81	0,8-1,47	1	1	RECT0004
RMS-0	0,07-0,6	0,8-2,41	1	1	RECT0007
RMS-1	0,07-0,74	0,8-2,41	1	1	RECT0005
RMS-2	0,35-0,81	0,8-2,41	1	1	RECT0008
RMS-3	0,45-0,92	0,8-2,41	1	1	RECT0009

PIECES DETACHEES APPAREIL A RECTIFIER

Side dresser spare part - Ersatzteile Egalisierapparat
Recambios para aparatos de rectificacion - Ricambi per apparecchio per rettificare

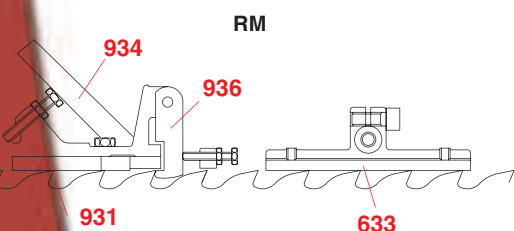
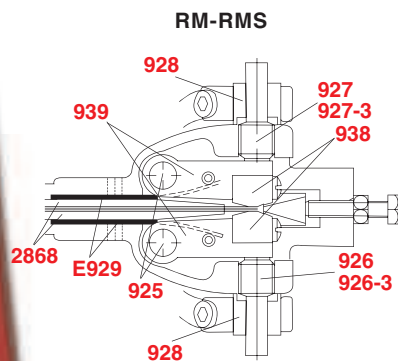
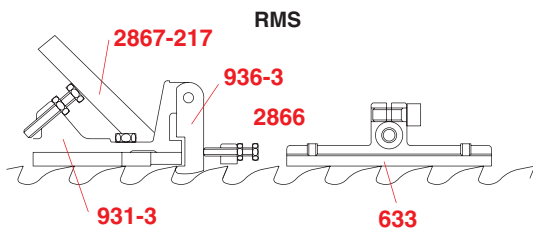

	REF	TYPE	UT	UC	CODE
AXE PORTE G	925-A	RM-RMS	1	1	ECRA0127
CORPS NUS	931	RM	1	1	ECRA0128
	931-3	RMS	1	1	ECRA0129
BUTES OSCILLANTES	936	RM	1	1	ECRA0024
	936-3	RMS	1	1	ECRA0025
ENTRETOISE	2866	RMS	1	1	ECRA0130
JEUX DE GRAIN	938-0	RM-RMS	1	1	ECRA0026
	938-1	RM-RMS	1	1	ECRA0027
	938-2	RM-RMS	1	1	ECRA0028
	938-3	RM-RMS	1	1	ECRA0029
LEVIERS A FOURCHE	934	RM	1	1	ECRA0131
	2867-2A	RMS	1	1	ECRA0132
POIGNÉES	924	RM	1	1	ECRA0133
	924-1A	RMS	1	1	ECRA0134
AXE	924-2A	RMS	1	1	ECRA0135
PORTE GRAIN	939	RM-RMS	1	1	ECRA0030
REGLETTE	2868	RM-RMS	1	1	ECRA0136
REGLETTE	633	RM-RMS	1	1	ECRA0081
RESSORT PLAT	E929	RM-RMS	1	1	ECRA0137
VIS DROITES	926	RM	1	1	ECRA0138
	926-3	RMS	1	1	ECRA0139
VIS GAUCHES	927	RM	1	1	ECRA0140
	927-3	RMS	1	1	ECRA0141

