

FRAISES ET PORTE-OUTILS : ACCESSOIRES

PROFILE CUTTER AND CUTTER HEAD: ACCESSORIES - PROFILFRÄSER UND FRÄSKOPF : ZUBEHÖR
FRESAS Y CABEZALES : ACCESORIOS - FRESE E TESTE : ACCESSORI

PLAQUETTES CARBURE REVERSIBLES

TCT Indexables Knives - HM Wendepplatten - Chapas Widia Reversibles - Coltelli Widia Reversibili

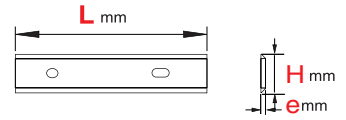

Nuance, Grade, Sorte, Calidad, Qualità
K 05

Dureté, Hardness, Härte, Durezza, Durezza
HM 1680 HV10

L	H	e	CODE	UC	UT
7.5	12	1.5	PLAQ0067		
8	12	1.5	PLAQ0103		
9.6	12	1.5	PLAQ0066		
10	12	1.5	PLAQ0104	10	1
15	12	1.5	PLAQ0051		
20	12	1.5	PLAQ0053		
12	12	1.5	PLAQ0048		
14	14	1.2	PLAQ0049		
14	14	1.5	PLAQ0050	10	1
14	14	2	PLAQ0068		
15	15	2.0	PLAQ0238	10	1
22	19	2.0	PLAQ0235		
18	18	1.95	PLAQ0062	10	1
18	18	2.5	PLAQ0105		
18	18	2.95	PLAQ0514		
30	12	1.5	PLAQ0054		
40	12	1.5	PLAQ0055	10	1
50	12	1.5	PLAQ0056		
60	12	1.5	PLAQ0057		
19.5	12	1.5	PLAQ0243		
29.5	12	1.5	PLAQ0244	10	1
39.5	12	1.5	PLAQ0245		
49.5	12	1.5	PLAQ0246		
24.5	12	4.0	PLAQ0470		
24.5	13	5.0	PLAQ0518		
34.0	16	4.0	PLAQ0405		
34.0	16	5.0	PLAQ0576		
16.0	22	5.0	PLAQ0291	Cf 45°	
16.0	22	5.0	PLAQ0000	Ry 3	
16.0	22	5.0	PLAQ0000	Ry 5	

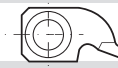
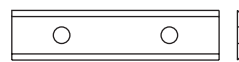
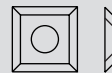
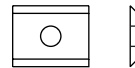

MANCHONS BOUT D'ARBRE

Axis sleeve - Wellen-Aufsatz - Manguito - Manciotto

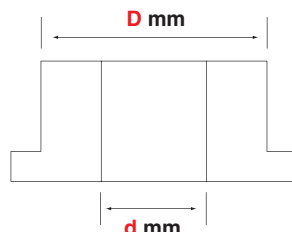

D mm		Code
30	M14 x 30	FRAI0220
50	M16 x 30	FRAI0221

FRAISES ET PORTE-OUTILS : ACCESSOIRES

PROFILE CUTTER AND CUTTER HEAD: ACCESSORIES - PROFILFRÄSER UND FRÄSKOPF : ZUBEHÖR
FRESAS Y CABEZALES : ACCESORIOS - FRESE E TESTE : ACCESSORI

BAGUES DE REDUCTION

Reducing bushes with collar - Reduzierbüchse mit Band - Anillos reducción eje - Anello di riduzione

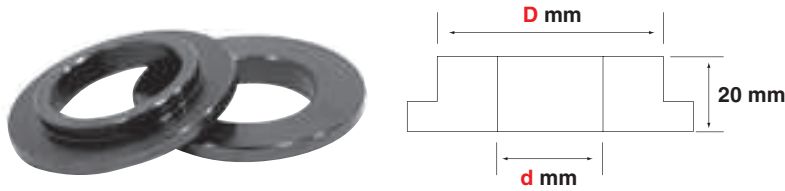

D mm	d mm	Code
30	20	FRAI0222
50	30	FRAI0223
50	40	FRAI0224

JEUX DE BAGUES DE REGLAGE ET DE REMPLISSAGE

Thickness adjustable rings - Zwischenringe zum Einstellen - Anillos de regulación - Anelli di regolazione



Nbre	E mm	d mm	Code
X 7	0,1-0,2-0,3-0,4-0,5-1-2	30	FRAI0225
X 7	0,1-0,2-0,3-0,4-0,5-1-2	50	FRAI0226
X 10	0,5-1-2-3-5-8-10-20-30-40	50	FRAI0227

CHAPEAUX 2 PIECES

2 half ring - 2 Halb Ringe - Tapas 2 piezas - 2 meta di anello



D mm	d mm	Code
50	30	FRAI0228
60	40	FRAI0229
70	50	FRAI0230

MANCHONS EPAULES AVEC CHAPEAU

Axis sleeve with collar - Wellenaufsatz mit Hutring - Eje respaldado con tapa - Manciotto

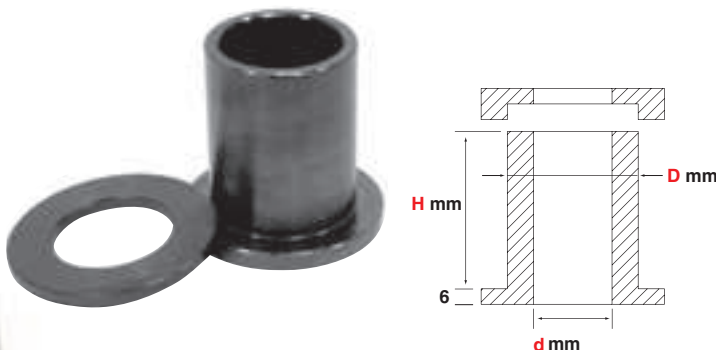

D mm	d mm	H mm	Code
50	30	60	FRAI0231
50	30	80	FRAI0232
60	40	60	FRAI0233
60	40	80	FRAI0234
60	40	100	FRAI0235
60	40	130	FRAI0236
60	40	160	FRAI0237

REGLET DE TOURPILLEUR

Cutter head rule - Messleiste - Regla para fresa - Regola per fresa



Code

PO0001

FRAISES ET PORTE-OUTILS : ACCESSOIRES

PROFILE CUTTER AND CUTTER HEAD: ACCESSORIES - PROFILFRÄSER UND FRÄSKOPF : ZUBEHÖR
FRESAS Y CABEZALES : ACCESORIOS - FRESE E TESTE : ACCESSORI

GUIDES A BILLES

Counter guides bushes for routing - Führungs-Lager - Cojinete tope - Guidi



D mm	AL = 30	AL = 50
65	FRAI0200	
70	FRAI0201	
75	FRAI0202	
80	FRAI0203	
85	FRAI0204	FRAI0210
90	FRAI0205	FRAI0211
100	FRAI0206	FRAI0212
110	FRAI0207	FRAI0213
115	FRAI0208	FRAI0214
120	FRAI0209	FRAI0215
130		FRAI0216
140		FRAI0217
150		FRAI0218
160		FRAI0219

* Livré sans roulement

delivered without bearing/geliefert ohne Lager/entregado sin cojinete

COFFRET DE 9 GUIDES A BILLES + 1 ROULEMENT

Set of 9 counter guides bushes + 1 bearing - Satz von 9 Führungslagern + 1 Kugellager
Kit de 9 cojinetes tope y 1 cojinete - Kit 9 guidi + 1 cuscinetto



d mm	d mm	Code
100 - 105 - 110		
115 - 120 - 125	50	FRAI0645
130 - 135 - 140		



FRAISES ET PORTE-OUTILS : ACCESSOIRES

PROFILE CUTTER AND CUTTER HEAD: ACCESSORIES - PROFILFRÄSER UND FRÄSKOPF : ZUBEHÖR
FRESAS Y CABEZALES : ACCESORIOS - FRESE E TESTE : ACCESSORI

ROULEMENTS A BILLES

Bearing - Kugellager - Cojinete - Cuscinetto

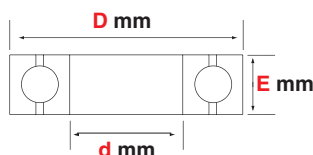

D mm	d mm	E mm	Code
52	25	15	FRAI0111
62	25	17	FRAI0112
55	30	13	FRAI0113
80	50	16	FRAI0114

POSITIONNEUR DE COUTEAUX

Knives positionner - Messer Positionierer - Colocador de cuchillas - Posizionatore di coltelli

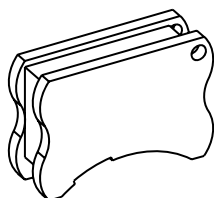

D mm de l'arbre	Code
60	PO0060
70	PO0070
80	PO0080
90	PO0090
100	PO0100
110	PO0110
120	PO0120

SAUTERELLES

Toggle clamps - Einspann-Werkzeug - Herramienta para apretar - Utensile di serraggio - cavalletta



SENS	FORCE	CODE
Horizontal	2300N	SERR0193
Vertical	2200N	SERR0192

PRESENTOIR

Stand - Präsentier-Ständer - Exponer- Visualizzare

CODE : FRAIPRESENTOIR
22 Emplacements
Composition et tarif nous consulter.

