

PORTE-OUTILS BOUVETAGE

JOINTS CUTTER HEAD - PROFILFRÄSER UND FRÄSKOPF : VERLEIMUNG
CABEZALES PARA JUNTAS - FRESE E TESTE PER GUARNIZIONE

PORTE OUTILS BOUVETAGE POUR MOULURIERE

Banding cutter head - Verleimfräser - Cabezal para juntas - Teste incastro per sconiciatrice



D mm	d mm	Z	Code
180	40	4	FRAI0343
180	40	4	FRAI0344
180	40	4	FRAI0345
180	40	4	FRAI0346
180	40	4	FRAI0347
180	40	4	FRAI0348
180	40	4	FRAI0349
180	40	4	FRAI0351

MANCHON FILETE

Cutter holder hub - Gewinde Aufsatz - Manguito fileteado - Ghiera filettate

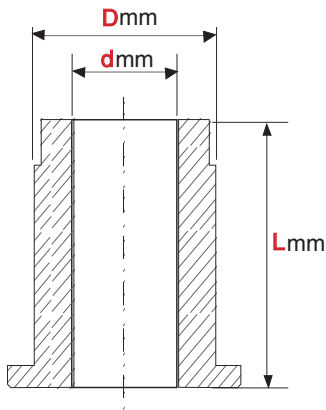

D mm	d mm	L mm	Code
50	40	95	FRAI0342

FRAI0343

FRAI0326
FRAI0328
FRAI0327

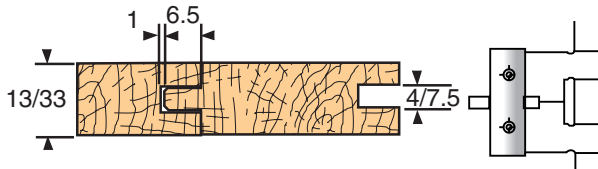

FRAI0329
FRAI0330

FRAI0344

FRAI0326
FRAI0328
FRAI0331

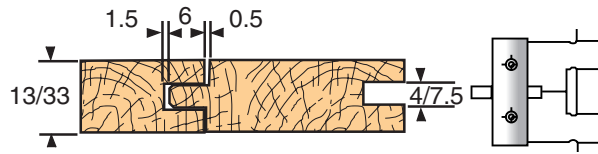

FRAI0329
FRAI0330

FRAI0345

FRAI0326
FRAI0328
FRAI0331
FRAI0341

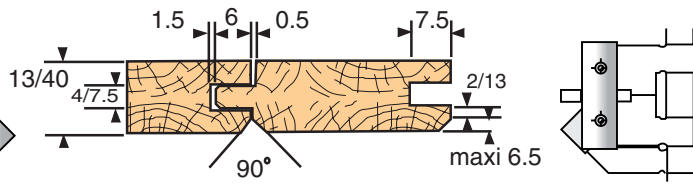

FRAI0329
FRAI0330
FRAI0340

FRAI0346

FRAI0340
FRAI0326
FRAI0328
FRAI0327
FRAI0341

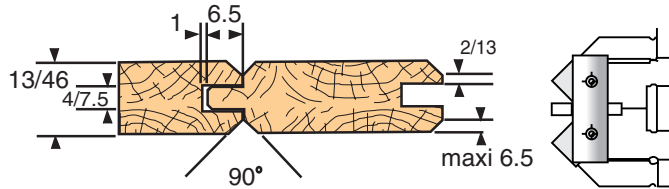

FRAI0341
FRAI0329
FRAI0330
FRAI0340

FRAI0347

FRAI0326
FRAI0328
FRAI0334

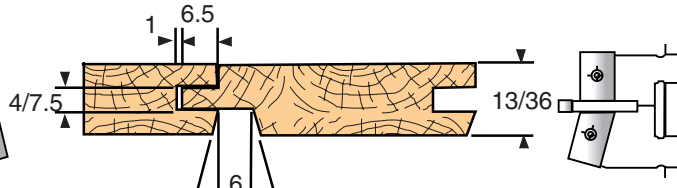

FRAI0329
FRAI0335

FRAI0348

FRAI0326
FRAI0328
FRAI0332

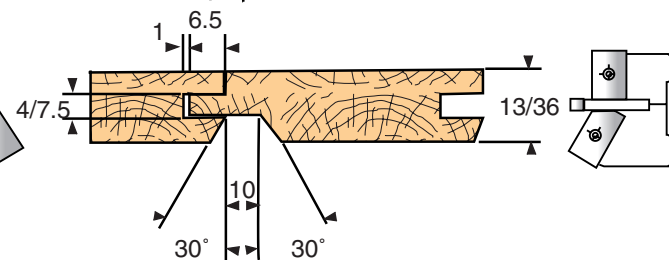

FRAI0329
FRAI0333

FRAI0349

FRAI0327
FRAI0328
FRAI0334

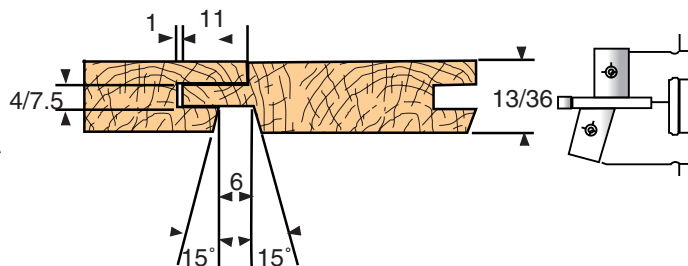

FRAI0336
FRAI0339

FRAI0351

FRAI0337
FRAI0328
FRAI0332

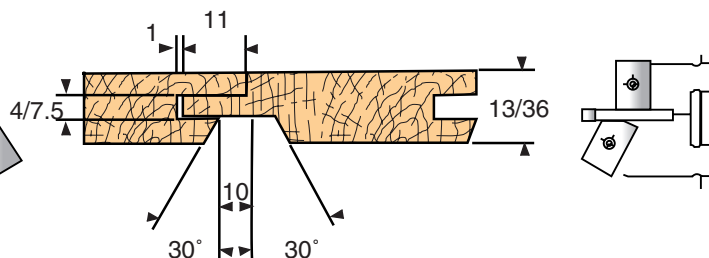

FRAI0336
FRAI0338

PORTE-OUTILS BOUVETAGE

JOINTS CUTTER HEAD - PROFILFRÄSER UND FRÄSKOPF : VERLEIMUNG
 CABEZALES PARA JUNTAS - FRESE E TESTE PER GUARNIZIONE

PORTE-OUTILS BOUVETAGE RAINURE LANGUETTE

Banding cutter head - Verleimfräser - Cabezal para juntas - Teste incastro



D mm	h mm	d mm	Z	Code
140	15	50	2+2	FRAI0326
140	15	50	2+2	FRAI0327
127	12	50	2+2	FRAI0328
155	20	50	2+2	FRAI0329
155	20	50	2+2	FRAI0330
139	15	50	2+2	FRAI0331
175	15	50	2+2	FRAI0332
155	20	50	2+2	FRAI0333
160	15	50	2+2	FRAI0334
155	20	50	2+2	FRAI0335
164	20	50	2+2	FRAI0336
149	15	50	2+2	FRAI0337
165	20	50	2+2	FRAI0338
164	20	50	2+2	FRAI0339
154	12	50	2+2	FRAI0340
154	12	50	2+2	FRAI0341

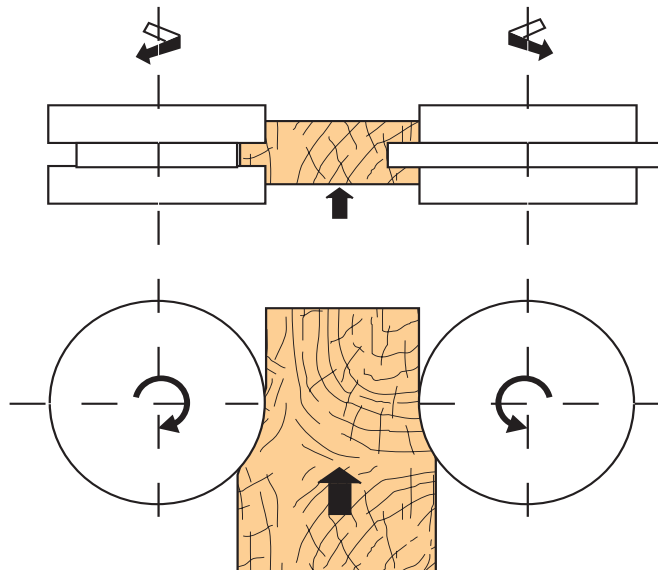

PORTE-OUTILS BOUVETAGE

JOINTS CUTTER HEAD - PROFILFRÄSER UND FRÄSKOPF : VERLEIMUNG
CABEZALES PARA JUNTAS - FRESE E TESTE PER GUARNIZIONE

PORTE-OUTILS A BOUVETER RAINURE LANGUETTE

Groove and tongue jointing cutter head - Nut und Federfräser

Juego de cabezales para machihembrar - Teste per incastro con spigolatori

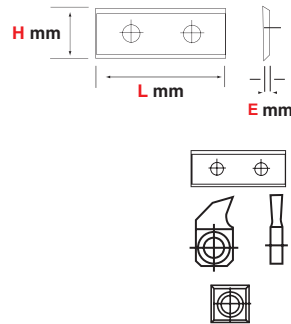
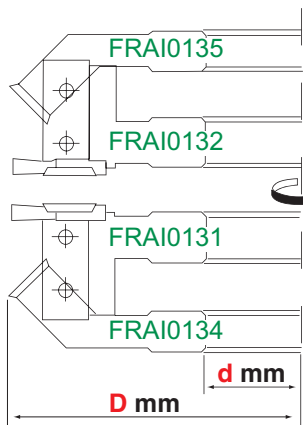
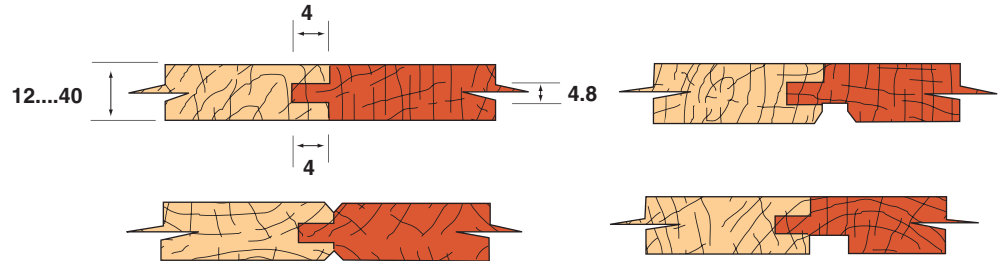

D mm	H mm	d mm	Z	Code
135	20	50	2	FRAI0131
135	20	50	2	FRAI0132
150	14	50	2	FRAI0134
150	14	50	2	FRAI0135

PLAQUETTE

Carbide Tips- HM-Plaketten - Plaqueta - Coltino

L mm	H mm	E mm	UC	UT	Code
30	12	1,5	10	1	PLAQ0054
13	25	4,0	2	1	PLAQ0177
14	14	2,0	10	1	PLAQ0068

PORTE-OUTILS A BOUVETER SYMETRIQUES

Edge banding cutter head - Symetrischer Verleimfräser - Juego de cabezales para machihembrar - Teste per giunzioni

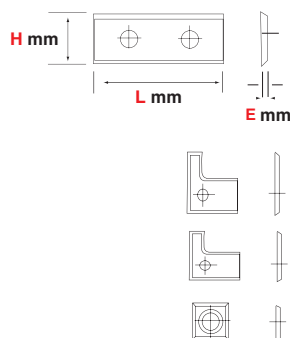
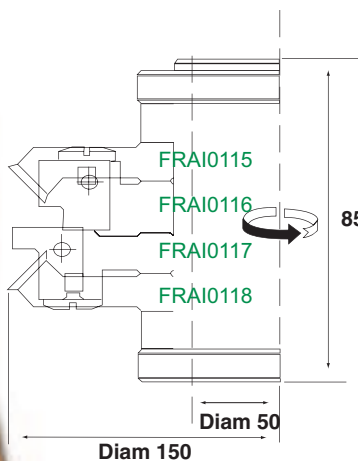
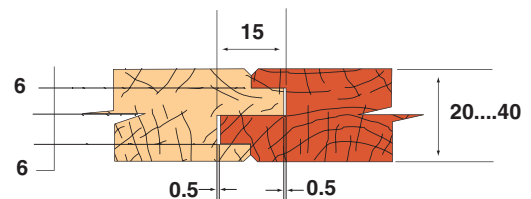

D mm	H mm	d mm	Z	Code
150	14	50	2	FRAI0115
135	20	50	2	FRAI0116
150	20	50	2	FRAI0117
150	14	50	2	FRAI0118

PLAQUETTE

Carbide Tips- HM-Plaketten - Plaqueta - Coltino

L mm	H mm	E mm	UC	UT	Code
20	20	1,5	2	1	PLAQ0115
20	20	1,5	2	1	PLAQ0116
14	14	2,0	10	1	PLAQ0068

PORTE-OUTILS BOUVETAGE

JOINTS CUTTER HEAD - PROFILFRÄSER UND FRÄSKOPF : VERLEIMUNG
 CABEZALES PARA JUNTAS - FRESE E TESTE PER GUARNIZIONE

PORTE-OUTILS BOUVETAGE DENTS DE SCIES

Glue joints cutter head - Keilzinkenfräser - Cabezal para juntas - Teste per giunzioni

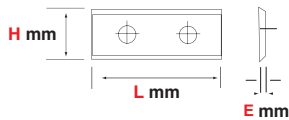
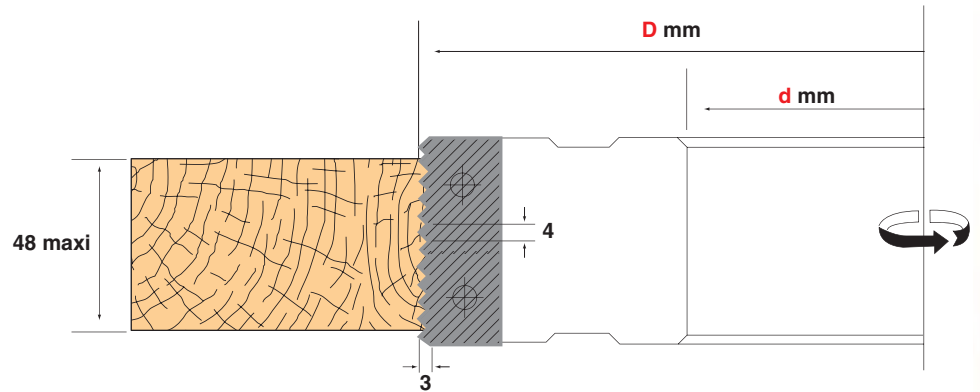

D mm	H mm	d mm	Z	Code
125	50	50	2	FRAI0019

PLAQUETTE

Carbide Tips- HM-Plaketten - Plaqueta - Colteline

L mm	H mm	E mm	UC	UT	Code
50	12	1,5	10	1	PLAQ0117



PORTE-OUTILS BOUVETAGE D'ANGLE

45° edge mitter banding cutter head - Gehrungsverleimfräser 45°
 Cabezal para juntas de 45° - Teste incastro angulo

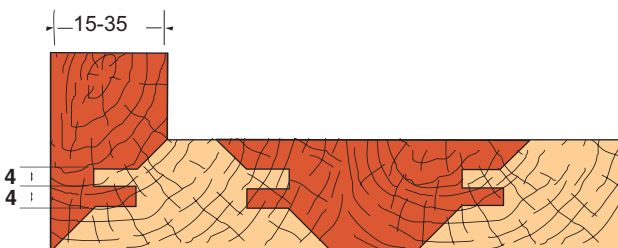
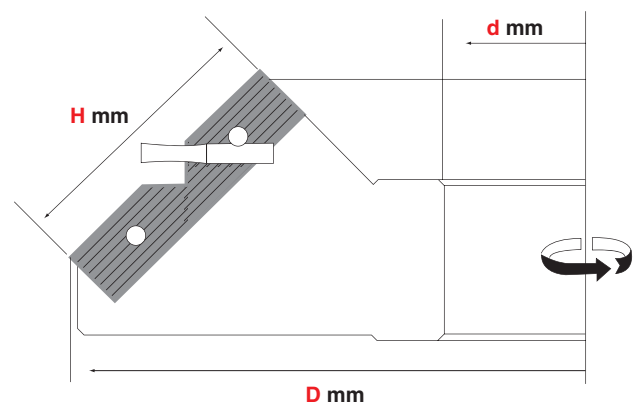

D mm	H mm	d mm	Z	Code
180	50	50	3+3	FRAI0303

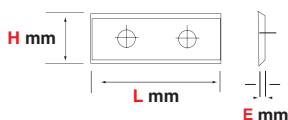

PLAQUETTE

Carbide Tips- HM-Plaketten - Plaqueta - Colteline

L mm	H mm	E mm	UC	UT	Code
50	20	2	2	1	PLAQ0404
16	33	4	2	1	PLAQ0405

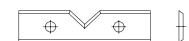

PORTE-OUTILS BOUVETAGE

JOINTS CUTTER HEAD - PROFILFRÄSER UND FRÄSKOPF : VERLEIMUNG
CABEZALES PARA JUNTAS - FRESE E TESTE PER GUARNIZIONE

PORTE-OUTILS BOUVETAGE MULTIPLE

Joints Cutter Head - Multi verleimfräser - Porta cuchillas para juntas - Teste per giunzioni



FRAI0531 (livré avec bague ép. 2mm)

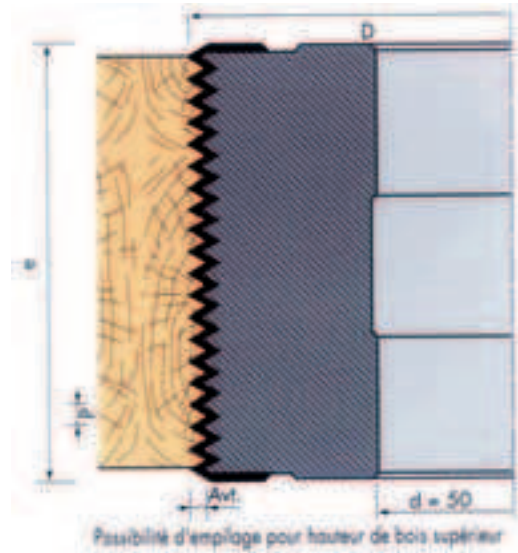

D mm	H mm	d mm	Z	Code
120	106	50	2	FRAI0531
120	106	50	2	FRAI0532

PLAQUETTE

Carbide Tips- HM-Plaketten - Plaqueta - Coltellino

L mm	H mm	E mm	UC	UT	Code
106,3	15	1,5	1	1	PLAQ0453
106,3	15	1,5	1	1	PLAQ0454



FRAI0532 (livré avec bague ép. 5,5mm)

Corps profilé. Fond plat

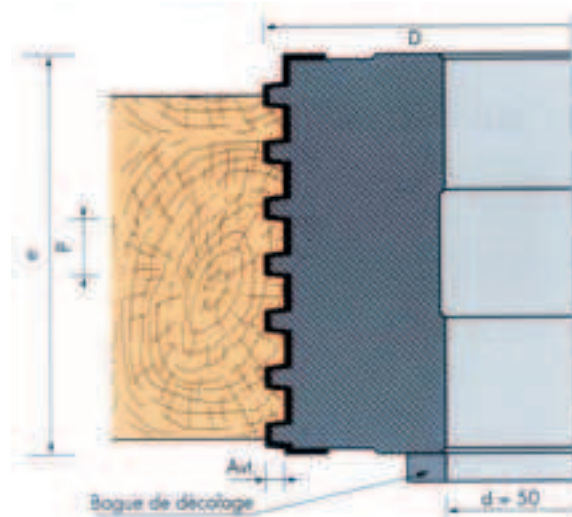

PORTE-OUTILS BOUVETAGE

JOINTS CUTTER HEAD - PROFILFRÄSER UND FRÄSKOPF : VERLEIMUNG
 CABEZALES PARA JUNTAS - FRESE E TESTE PER GUARNIZIONE

PORTE-OUTILS BOUVETAGE HAUTEUR REGLABLE 13 A 62 MM

Joints cutter head extensible from 13 to 62mm height - Verleimfräser von 13 bis 62mm Höhe einstellbar
 Porta herramientas para juntas. altura ajustable de 13 hasta 62 mm - Teste giunzioni altezza regolabile 13 a 62 mm

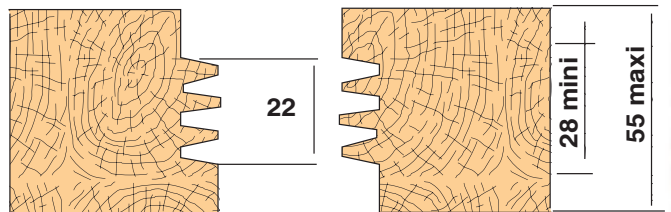
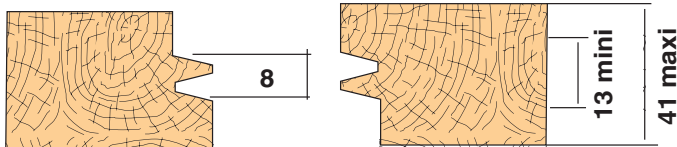
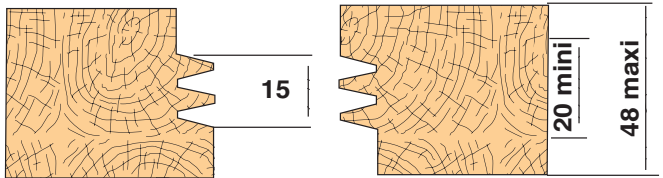
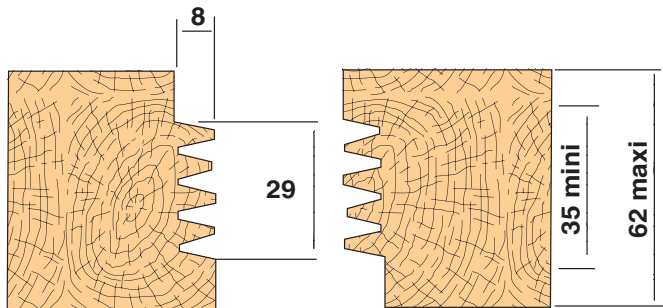
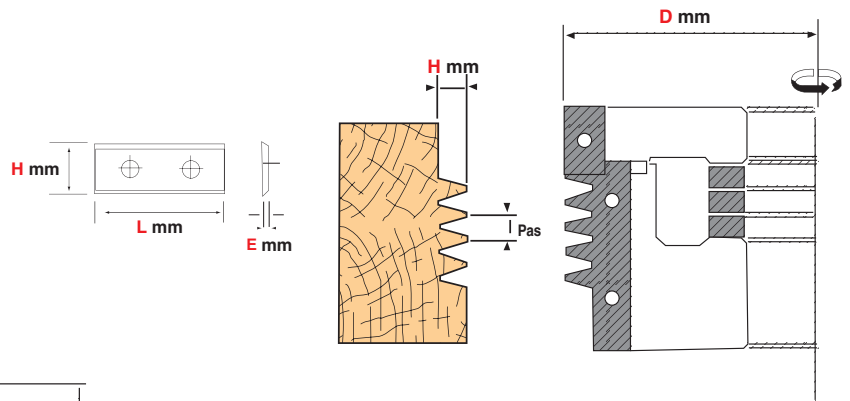

D mm	H mm	d mm	Z	Code
150	52+20	50	3+3	FRAI0354

PLAQUETTE

Carbide Tips - HM-Plaketten - Plaqueta - Coltellino

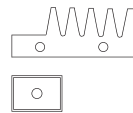

L mm	H mm	E mm	UC	UT	Code
50	25	2.0	10	1	PLAQ0406
20	12	1.5	10	1	PLAQ0053

PORTE-OUTILS BOUVETAGE A PLAQUETTES REVERSIBLES

Joints cutter head - Verleimfräser von - Porta herramientas para juntas - Teste giunzioni altezza



D mm	H mm	d mm	Z	Code
125	50	50	2	FRAI0669

PLAQUETTE

Carbide Tips - HM-Plaketten
 Plaqueta - Coltellino

Code
PLAQ0550
PLAQ0551
PLAQ0552

