

EBENISTERIE - PROFILS / CONTRE-PROFILS

CABINET MAKING / PROFIL AND COUNTER PROFIL - PROFILFRÄSER UND GEGENPROFILSATZ
EBANISTERIA - MOLDURA / CONTRA MOLDURA - FRESE E TESTA EBANISTARIA

PORTE-OUTILS EBENISTERIE PROFILS / CONTRE-PROFILS

Cabinet making / Profil and counter profil - Profilfräser und Gegenprofilsatz
Juego de moldura y contramoldura - Frese e testa ebanistaria

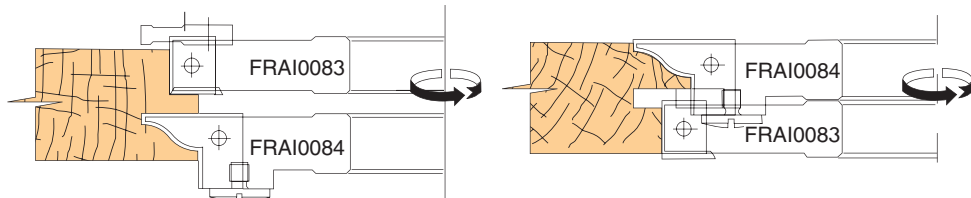

D mm	H mm	d mm	Z	Avt	Code
145	15	50	3		FRAI0083
160	20	50	3+3	15	FRAI0084

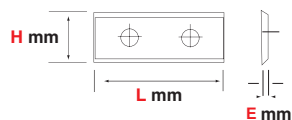
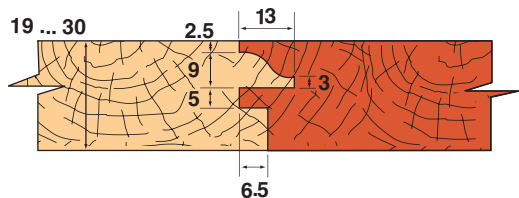

PLAQUETTE

Carbide Tips- HM-Plaketten - Plaqueta - Coltélino

L mm	H mm	E mm	Uc	Ut	Code
20	27	1,5	3	1	PLAQ0179
15	12	1,5	10	1	PLAQ005
14	14	2,0	10	1	PLAQ006
13	25	5	3	1	PLAQ0180

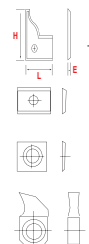

PORTE-OUTILS EBENISTERIE PROFILS / CONTRE-PROFILS

Cabinet making / Profil and counter profil - Profilfräser und Gegenprofilsatz
Juego de moldura y contramoldura - Frese e testa ebanistaria

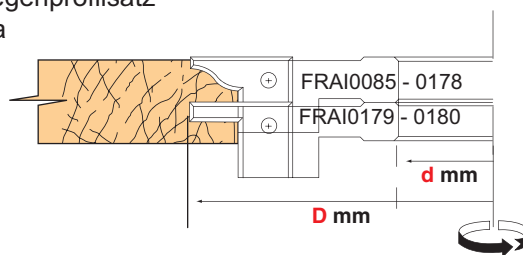

D mm	H mm	d mm	Z	Avt	Code
160	20	50	3	10	FRAI0085
160	20	50	3	13	FRAI0178
160	20	50	3	10	FRAI0179
160	20	50	3	13	FRAI0180

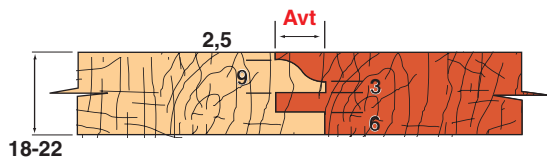

PLAQUETTE

Carbide Tips- HM-Plaketten - Plaqueta - Coltélino

L mm	H mm	E mm	Avt	UC	UT	Code
20	27	1,5	10	3	1	PLAQ0181
20	27	1,5	13	3	1	PLAQ0182
20	27	1,5	10	3	1	PLAQ0183
20	27	1,5	13	3	1	PLAQ0184

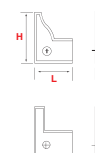

EBENISTERIE - PROFILS / CONTRE-PROFILS

CABINET MAKING / PROFIL AND COUNTER PROFIL - PROFILFRÄSER UND GEGENPROFILSATZ
EBANISTERIA - MOLDURA / CONTRA MOLDURA - FRESE E TESTA EBANISTARIA

PORTE-OUTILS MOULURE PORTE PROFILS

Profil cutter head - Profilfräser - Juego de cabezales para puertas - Testa modalatura

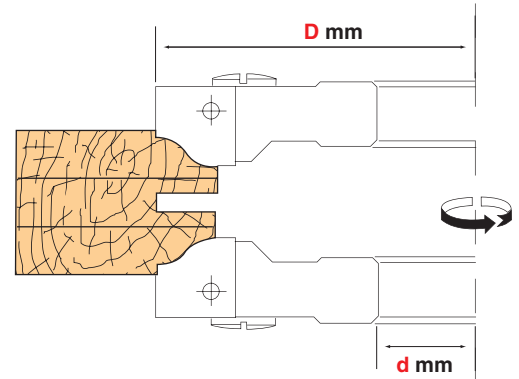

D mm	H mm	d mm	Z	Avt	A	A	B	B	C	C
160	20	50	3	10	FRAI0087	FRAI0088	FRAI0093	FRAI0094		
160	20	50	3	13	FRAI0089	FRAI0090	FRAI0095	FRAI0096		
160	20	50	3	15	FRAI0091	FRAI0092	FRAI0097	FRAI0098	FRAI0099	FRAI0100
160	20	50	3	20					FRAI0101	FRAI0102

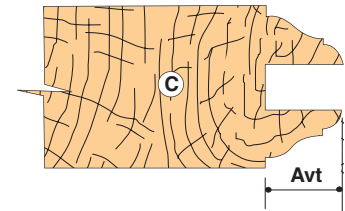
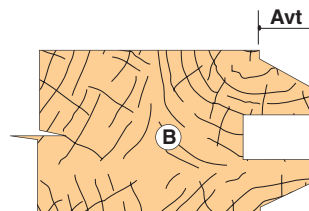
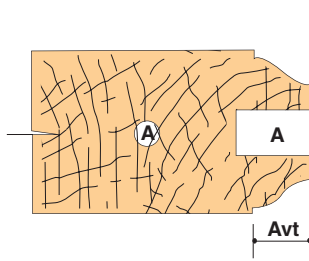

PO FRAI0087 = PO FRAI0093
PO FRAI0089 = PO FRAI0095
PO FRAI0091 = PO FRAI0097
PO FRAI0088 = PO FRAI0094
PO FRAI0090 = PO FRAI0096
PO FRAI0092 = PO FRAI0098 - PO FRAI0100

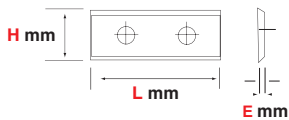

PLAQUETTE - Carbide Tips- HM-Plaketten - Plaqueta - Coltellino

L mm	H mm	E mm	Avt	UC	UT	A	A	B	B	C	C
20	20	1,5	10	3	1	PLAQ0185	PLAQ0186	PLAQ0191	PLAQ0192		
20	20	1,5	13	3	1	PLAQ0187	PLAQ0188	PLAQ0193	PLAQ0194		
20	20	1,5	15	3	1	PLAQ0189	PLAQ0190	PLAQ0195	PLAQ0196		
20	27	1,5	20	3	1					PLAQ0197	PLAQ0198
20	30	2,0	20	3	1					PLAQ0199	PLAQ0200

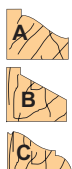

Outils travaillant dessus
Tool working above
Oben arbeitende Werkzeuge
Herramienta trabajando por arriba
Utensili lavorando sopra



Outils travaillant dessous
Tool working underneath
Unten arbeitende Werkzeuge
Herramienta trabajando por debajo
Utensili lavorando sotto

EBENISTERIE - PROFILS / CONTRE-PROFILS

CABINET MAKING / PROFIL AND COUNTER PROFIL - PROFILFRÄSER UND GEGENPROFILSATZ
EBANISTERIA - MOLDURA / CONTRA MOLDURA - FRESE E TESTA EBANISTARIA

PORTE-OUTILS MOULURE PORTE CONTRE-PROFILS

Set of cutter head for doors - Profil-Fräserkopf für Profil-Türen - Juego de cabezales para puertas- Testa modalatura

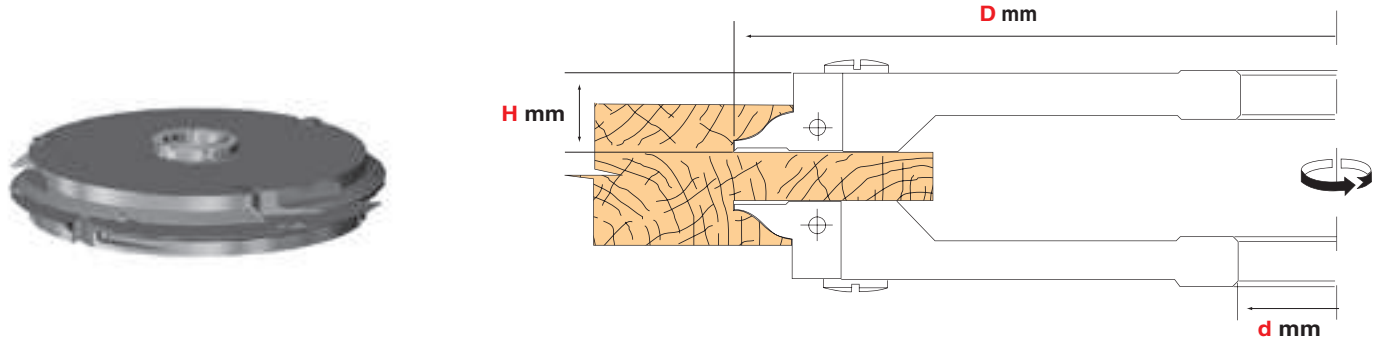

D mm	H mm	d mm	Z	Avt	A	A	B	B	C	C
302	20	50	3+3	10	FRAI0181	FRAI0182	FRAI0187	FRAI0188		
302	20	50	3+3	13	FRAI0183	FRAI0184	FRAI0189	FRAI0190		
302	20	50	3+3	15	FRAI0185	FRAI0186	FRAI0191	FRAI0192	FRAI0193	FRAI0194
302	20	50	3+3	20					FRAI0195	FRAI0196

PO FRAI0181 = PO FRAI0187
PO FRAI0183 = PO FRAI0190
PO FRAI0185 = PO FRAI0191 = PO FRAI0193
PO FRAI0182 = PO FRAI0188
PO FRAI0184 = PO FRAI0190
PO FRAI0186 = PO FRAI0192 = PO FRAI0194

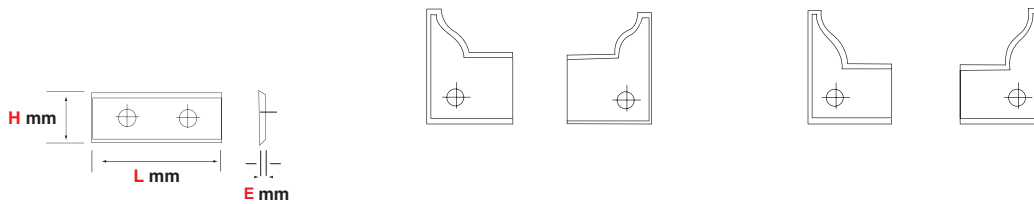

PLAQUETTE - Carbide Tips- HM-Plaketten - Plaqueta - Coltélino

L mm	H mm	E mm	Avt	UC	UT	A	A	B	B	C	C
20	27	1,5	10	3	1	PLAQ0203	PLAQ0204	PLAQ0209	PLAQ0210		
20	27	1,5	13	3	1	PLAQ0205	PLAQ0206	PLAQ0211	PLAQ0212		
20	27	1,5	15	3	1	PLAQ0207	PLAQ0208	PLAQ0213	PLAQ0214	PLAQ0215	PLAQ0216
20	34	2,0	20	3	1					PLAQ0217	PLAQ0218

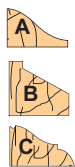

Outils travaillant dessus
Tool working above
Oben arbeitende Werkzeuge
Herramienta trabajando por arriba
Utensili lavorando sopra



Outils travaillant dessous
Tool working underneath
Unten arbeitende Werkzeuge
Herramienta trabajando por debajo
Utensili lavorando sotto

EBENISTERIE - PROFILS / CONTRE-PROFILS

CABINET MAKING / PROFIL AND COUNTER PROFIL - PROFILFRÄSER UND GEGENPROFILSATZ
 EBANISTERIA - MOLDURA / CONTRA MOLDURA - FRESE E TESTA EBANISTARIA

PORTE-OUTILS EBENISTERIE PROFILS / CONTRE-PROFILS

Cabinet making / Profil and counter profil - Profilfräser und Gegenprofilsatz
 Juego de moldura y contramoldura - Frese e testa ebanistaria

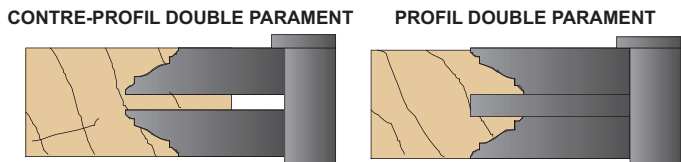
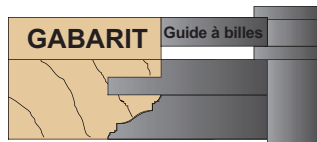
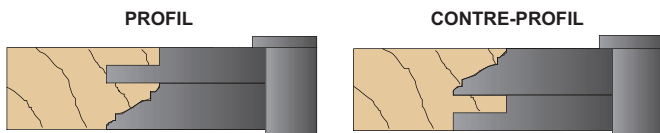
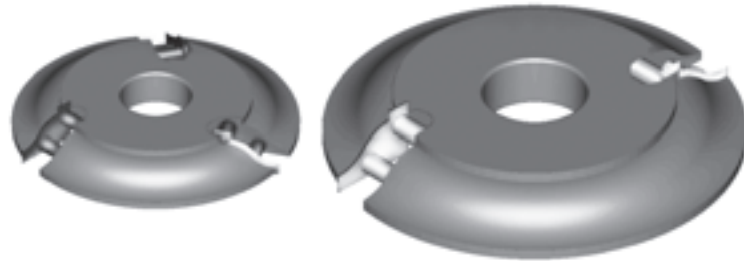

D mm	d mm	Z	Avt	Code
140	50	3	15	FRAI0625
140	50	3	15	FRAI0626
140	50	3	20	FRAI0627
140	50	3	20	FRAI0628
140	50	3	15	FRAI0629
140	50	3	15	FRAI0630
140	50	3	20	FRAI0631
140	50	3	20	FRAI0632
140	50	3	15	FRAI0633
140	50	3	20	FRAI0634

