

PORTE-OUTILS PLATE BANDE

PLANEL RAISING CUTTER HEAD - WENDEPLATTEN-ABPLATTFRÄSER
CABEZAL DE PLAFONES - FRESE PIATTABANDE

Panel raising cutter head - Abplattfräser - Cabezal de plafones - Frese piattabande con coltellini cambiabili
PORTE-OUTILS PLATE BANDE A PLAQUETTES JETABLES

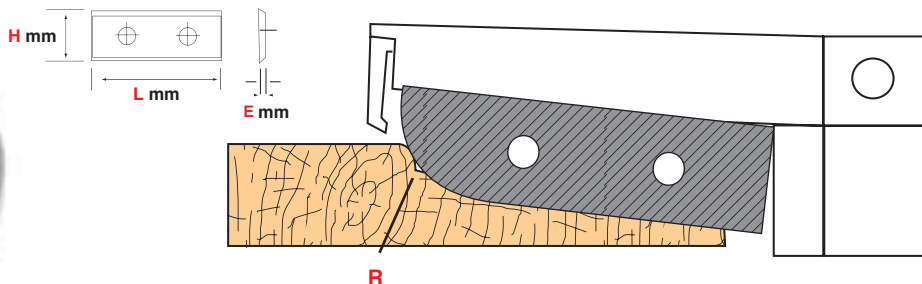

FRAI0255

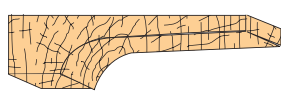

FRAI0258

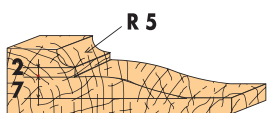

FRAI0259



FRAI0260

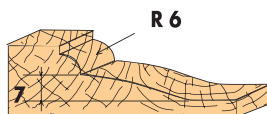

FRAI0261

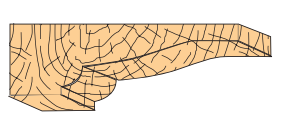

FRAI0262

D mm	H mm	d mm	Z		
180	30	50	3	FRAI0255	FRAI0258
180	30	50	3	FRAI0259	FRAI0260
180	30	50	3	FRAI0261	FRAI0262

PLAQUETTE - Carbide Tips- HM-Plaketten - Plaqueta - Coltellino

L mm	H mm	E mm	UC	UT	Code	Code
50	12	1,5	3	1	PLAQ0262	PLAQ0263
50	12	1,5	3	1	PLAQ0260	PLAQ0261
50	12	1,5	3	1	PLAQ0258	PLAQ0259

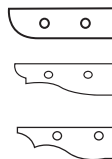

PORTE-OUTILS PLATE BANDE DOUCINE

Panel raising cutter head - Abplattfräser - Cabezal de plafones - Frese piattabande con coltellini cambiabili



D mm	H mm	d mm	Z		
180	30	50	2+2	FRAI0489	FRAI0490

Le porte-outils plate bande doucine livré avec 4 profils

PLAQ0484 PLAQ0485 PLAQ0483 PLAQ0480

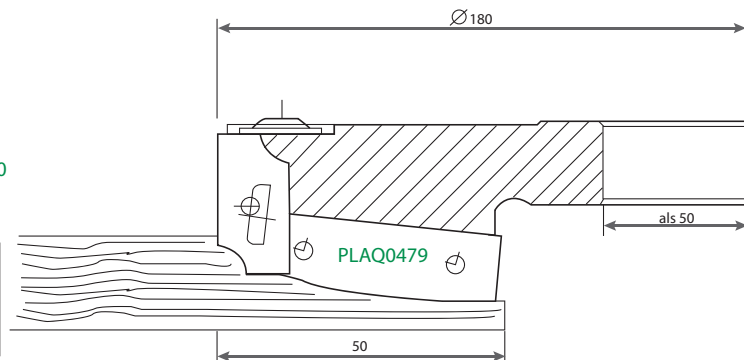
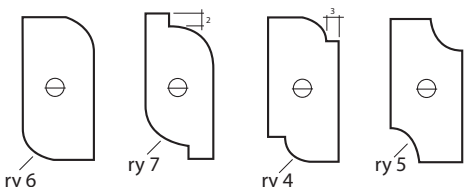

"Porte outils équipé de 2 plaquettes carbure 40x12x1,5 profilées et 2 plaquettes carbure réversible 23,5x12x1,5 profilées"

PORTE-OUTILS PLATE BANDE

PLANEL RAISING CUTTER HEAD - WENDEPLATTEN-ABPLATTFRÄSER
CABEZAL DE PLAFONES - FRESE PIATTABANDE

PORTE-OUTILS PLATE BANDE MULTI-PROFILS

Panel raising combi-cutter head - Kombiniertes Abplattfräser
Cabezal de plafones combinado - Frese piattabande multi uso

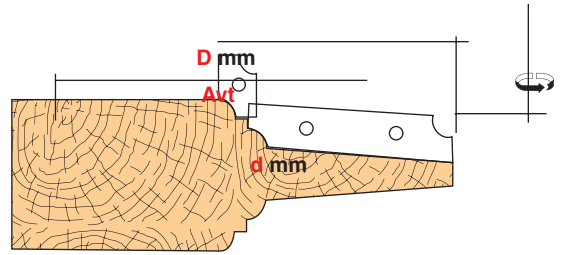

D mm	H mm	d mm	Z		
200	30	50	2+2	FRAI0304	FRAI0455

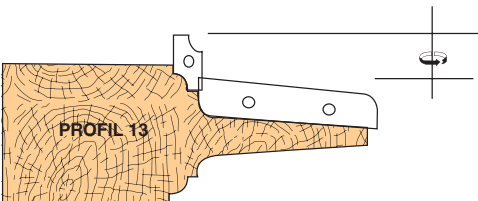
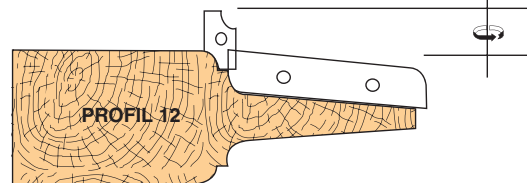
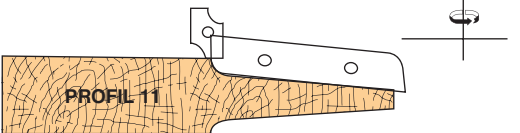
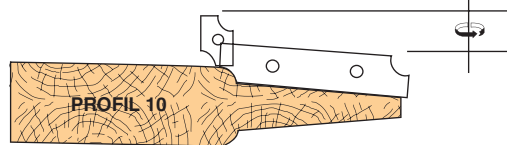
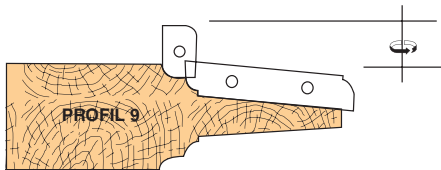
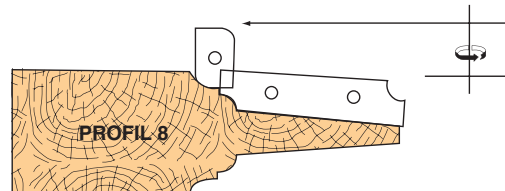
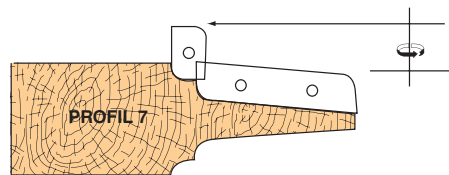
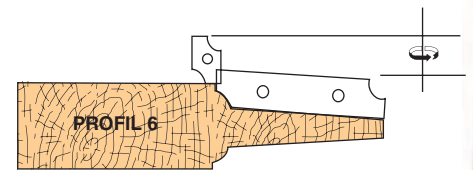
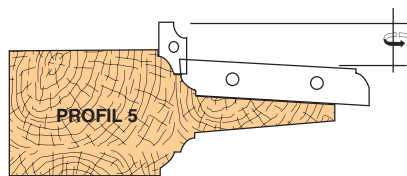
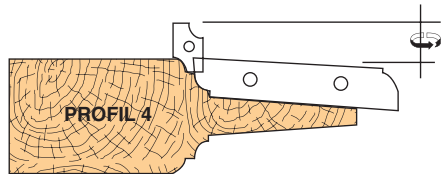
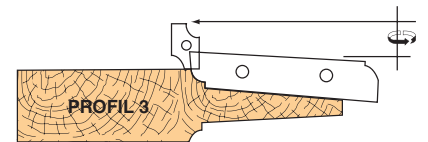
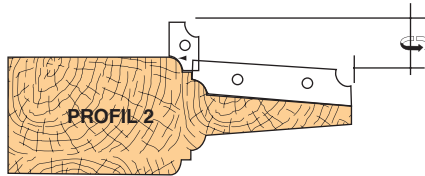
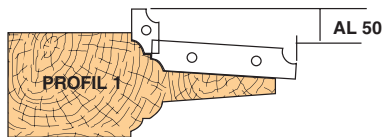

PLAQUETTE - Carbide Tips- HM-Plaketten - Plaqueta

L mm	H mm	E mm	UC	UT	Code	Code
20	12	1.5	4	1	PLAQ0409	PLAQ0414
20	12	1.5	4	1	PLAQ0410	PLAQ0415
60	12	1.5	4	1	PLAQ0411	PLAQ0416
60	12	1.5	4	1	PLAQ0412	PLAQ0417
60	12	1.5	4	1	PLAQ0413	PLAQ0418

