

POSTE A TRONCONNER MOBILE

MOBILE CHAIN SAWS - MOBILSTATION
MAQUINA MÓVIL PARA TRONZAR - TAGLIO MOBILE CON CATENE

TRONCONNEUSES ELECTRIQUES

Electric chain saw - Elektro-Kettensägen - Motosierra eléctrica - Motosega eletrica

E28

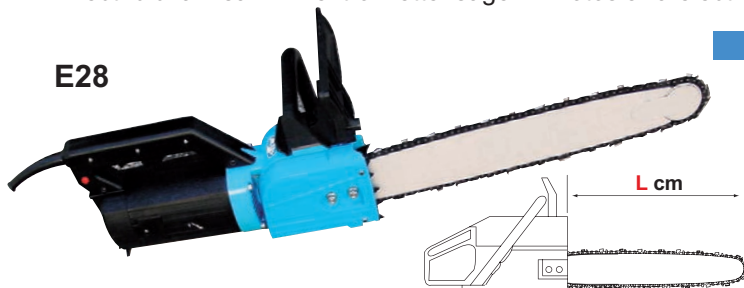

L cm				Code
43	230 V	2,8	10	TRONE2843
53	230 V	2,8	10	TRONE2853
63	230 V	2,8	10,5	TRONE2863
75	230 V	2,8	10,5	TRONE2875
90	230 V	2,8	10,5	TRONE2890

* Autre voltage sur demande

* Different voltage on request * Andere Voltierung auf Anfrage

* Otro voltaje a petición * Altre tensioni su richiesta

POSTE A TRONCONNER MOBILE

MOBILE CHAIN SAWS - MOBILSTATION - MAQUINA MÓVIL PARA TRONZAR - TAGLIO MOBILE CON CATENE

380 V

ECOSTAR
MACH0384



- Précision :
+/- 4mm

					CODE
7,5w / 10ch	1	120x120	190	2110x1120x1200	MACH0384
7,5w / 10ch	1	120x120	193	2110x1120x1200	MACH0271
11w / 15ch	1	120x120	193	2110x1120x1200	MACH0270



TKSF-L
MACH0271

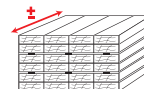

- Précision :
+/- 2mm



POSTE A TRONCONNER FIXE A PAQUET

Fixed Chain Saws - Feststation - Máquina Fijo - Taglio fisso con catene per pacco

380 V

TKSF-L
(Fixe)
MACH0383

					CODE
7,5w / 10ch	1	120x120	290	2110x1120x1200	MACH0383
11w / 10ch	1	120x120	293	2110x1120x1200	MACH0270

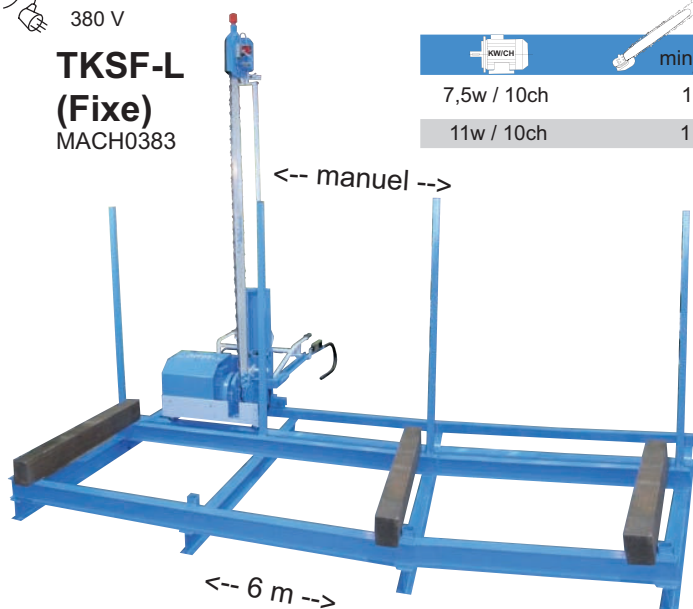

- Précision / Accuracy / Genauigkeit

Prección / Accuratezza :

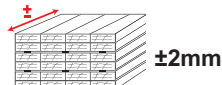

- Déplacement / Removal / Beseitigung

Remoción / Spostamento :

manuel

POSTE A TRONCONNER FIXE A PAQUET

BUNDLE FIXED CHAIN SAWS - BÜNDEL FESTSTATION
 MAQUINA FIJO PARA TRONZAR PARA PAQUETE - TAGLIO FISSO CON CATENE PER PACCO

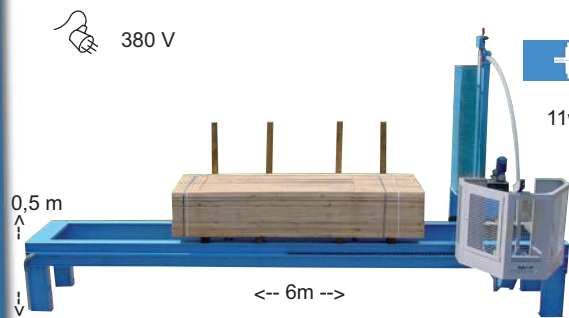

MOBILCUT

380 V	min/m ²	L	KG	CODE
11w / 15ch	1,8	120x120	2400	7300x3300x2300
- Remonter / Wind / Aufziehen / Dar cuerda / Caricare :				
- Précision / Accuracy / Genauigkeit / Precisión / Accuratezza :				
- Déplacement / Removal / Beseitigung / Remoción / Spostamento :				
Manuel : MACH0320 - Electrique : MACH0321				

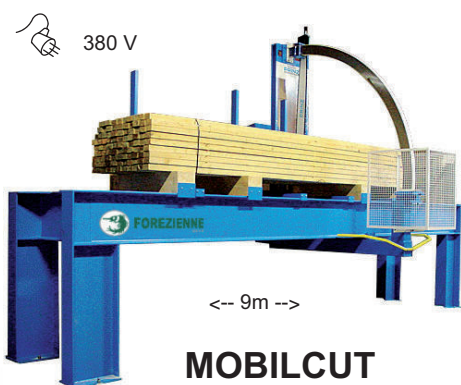

MOBILCUT CONFORT

380 V	min/m ²	L	KG	CODE
11w / 15ch	1,8	120x120	4000	0000x0000x0000
- Remonter / Wind / Aufziehen / Dar cuerda / Caricare :				
- Précision / Accuracy / Genauigkeit / Precisión / Accuratezza :				
- Déplacement / Removal / Beseitigung / Remoción / Spostamento :				



CUTSTAR

380 V	min/m ²	L	KG	CODE
15w / 20ch	1,5	120x120	5000	0000x0000x0000
- Remonter / Wind / Aufziehen / Dar cuerda / Caricare :				
- Précision / Accuracy / Genauigkeit / Precisión / Accuratezza :				
- Déplacement / Removal / Beseitigung / Remoción / Spostamento :				

OPTION

Options - Optionen - Opciones - opzione

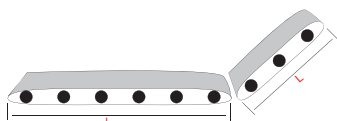

Bande Transporteuse
 carrier bunch
 Haufen Bote
 grupo transportista
 Nastro trasportatore

L/m	KG	CODE
7	150Kg/m	0000x0000x0000 MACH0304
8	150Kg/m	0000x0000x0000 MACH0305
3V	150Kg/m	0000x0000x0000 MACH0306

*Les machines sont vendues: (sans guide, sans chaîne)

Machines are sold: (without guide bar, without chain) - Maschinen, die verkauft werden: (ohne Führung, ohne Sägekette)
 Las máquinas se venden: (sin espadas, senza cadenas) - Macchine sono venduti: (zenza barra, senza catena)